

CABLE CRIMPING TOOL & CABLE CUTTER





HYDRAULIC CRIMPING TOOL



Item No:YQK-70



Item No:YQK-240

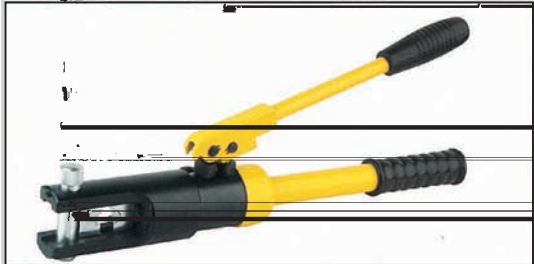

Item No:YYQ-120



Item No:YQK-300

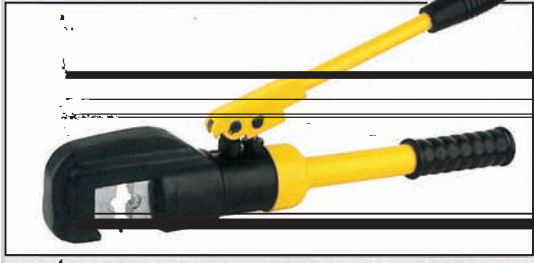

Item No:YYQ-120A



HYDRAULIC CRIMPING TOOL

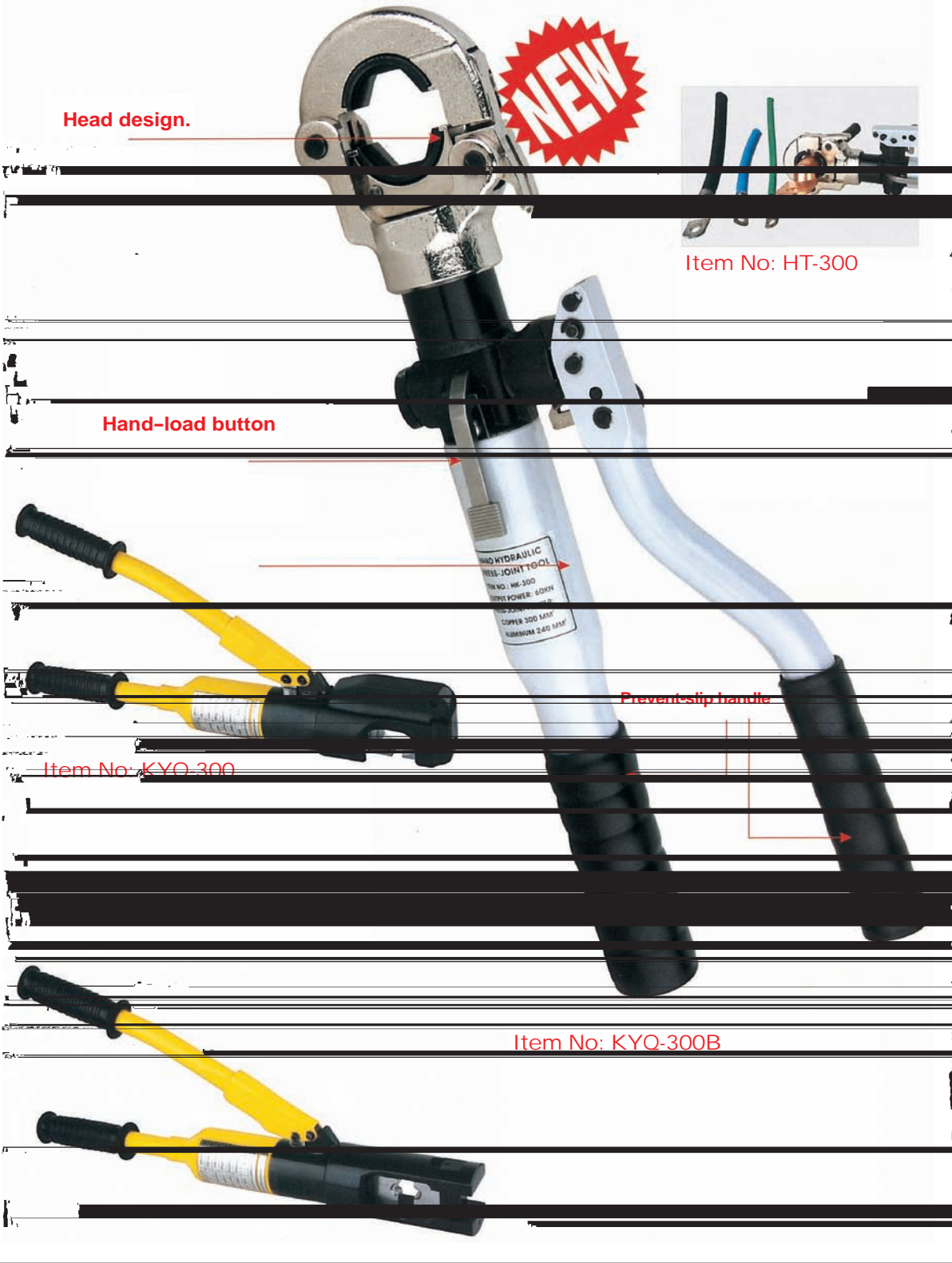

Head design.

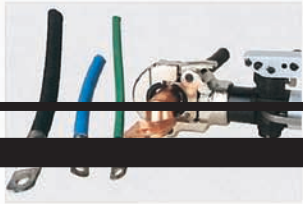

Item No: HT-300

Hand-load button



Item No: KYO-300

Prevent-slip handle

Item No: KYO-300B



HYDRAULIC CRIMPING TOOL



Item No:KYQ-300C

Item No:KYQ-400

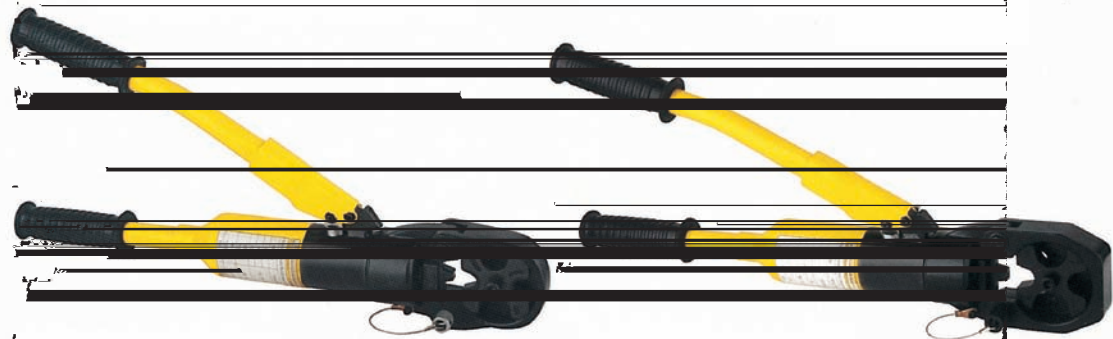

Item No:KDG-150

Item No:KDG-200

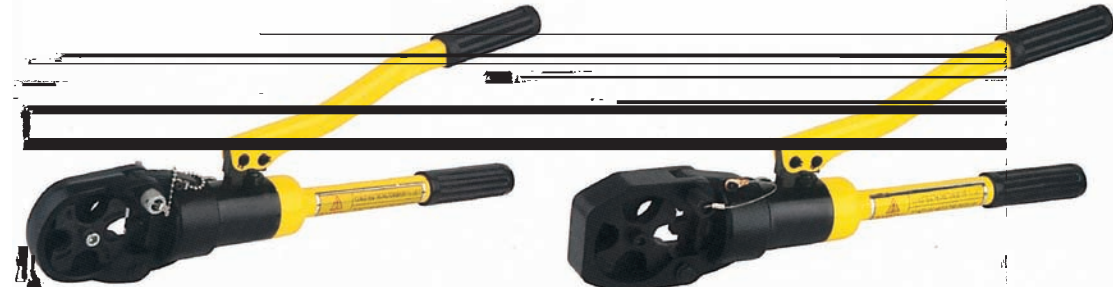

Item No:KDG-150A

Item No:KDG-200A



HYDRAULIC CRIMPING TOOL

HAND HYDRAULIC COMPRESSION TOOL

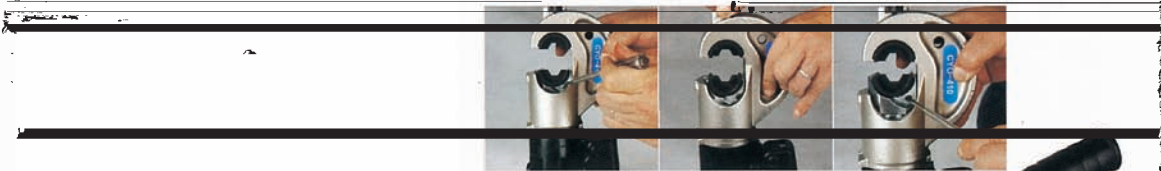

Item No:CYO-410



HYDRAULIC Crimping Tool



Item No:CYO-430



Item No:CYO-510B

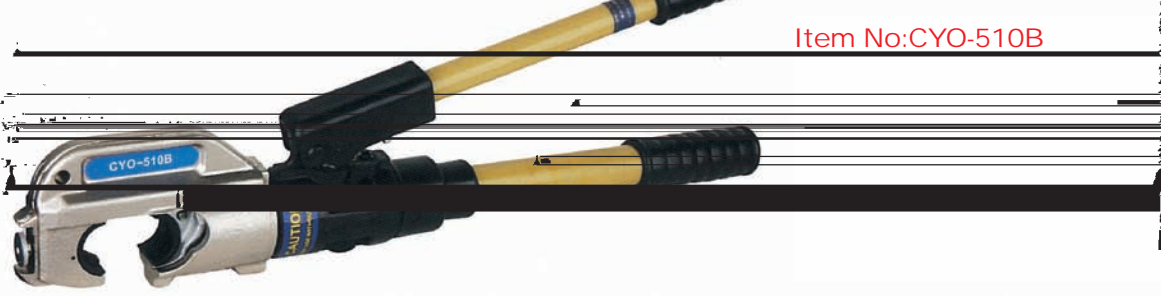



HYDRAULIC CRIMPING TOOL

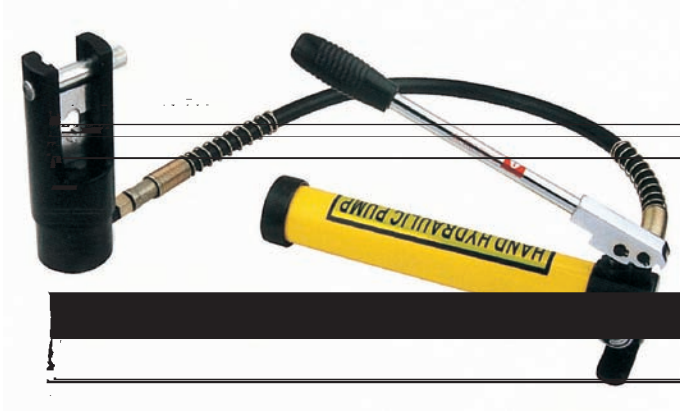

Item No: FYQ-300

HYDRAULIC CRIMPING TOOL

Item No: FYQ-300C

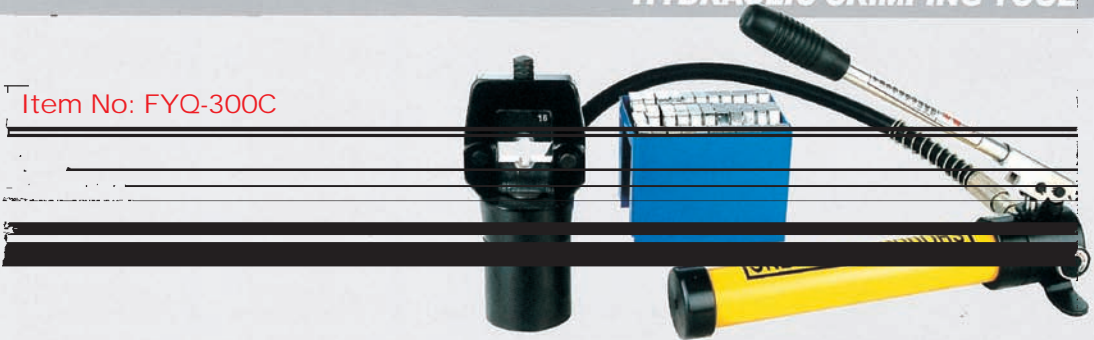

Item No: FYQ-400



Item No: CO-400B



HYDRAULIC CRIMPING TOOL

FUNCTION



Item No: FYQ-630

Item No: FYQ-630A

Item No: FYQ-630B

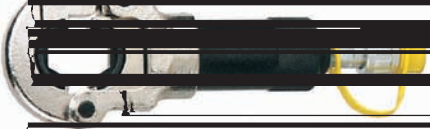

Item No: FHT-300

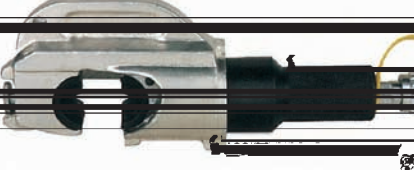

Item No: SHP-430H

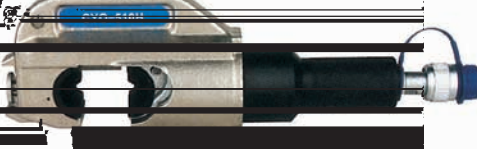

Item No: CYO-510H



MECHANICAL CRIMPING TOOL



Item No: JY-0650

Item No: JY-0650A

Item No: JY-16120, JY-06120



Item No: JY-25150

Item No: CT-38

Item No: CT-80



Item No: KH-100

Item No: KH-150

Item No: KH-230



MECHANICAL CRIMPING TOOL



Item No: QW-12A



Item No: QW-18A

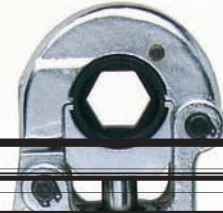

Item No: JYJ-300B

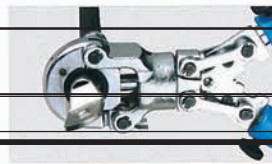

Item No: JYJ-240



Item No: JQG-185

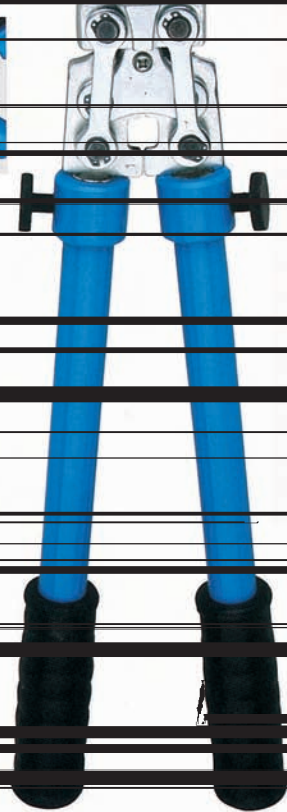

Item No: JT 300



HAND CRIMPING TOOL



Item No: DG-I

Item No: DG-II

Item No: DG-III

Item No: HS-TMA

Item No: HD-6L

Item No: HD-6LA

Item No: HD-6M

Item No: HD-8L



HAND CRIMPING TOOL



Item No: HD-8LA



Item No: HD-10L

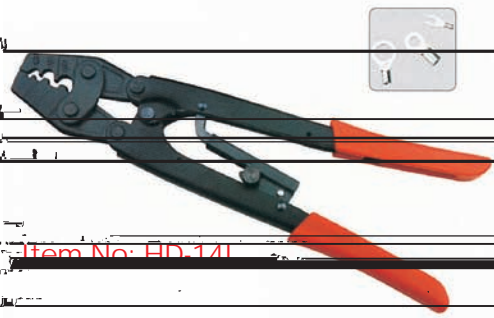

Item No: HD-14L



Item No: HD-16L



Item No: HX-16



Item No: HD-25L

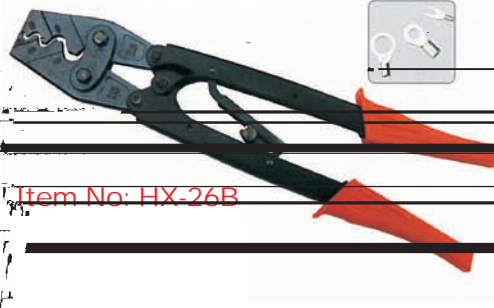

Item No: HX-26B



Item No: HD-50L



HAND CRIMPING TOOL



Item No: HD-003



Item No: HD-004

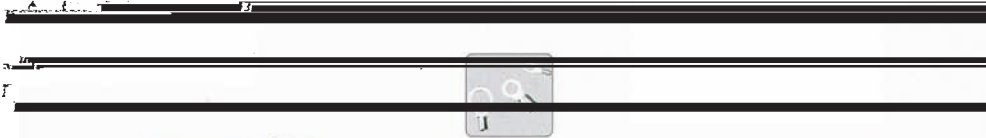

Item No: HD-005

Item No: HD-006



Item No: G-301H

Item No: G-230C



Item No: HS-10

Item No: HS-101





HAND CRIMPING TOOL



Item No: HS-103



Item No: HS-04WF



Item No: HD-005H



Item No: SN-001

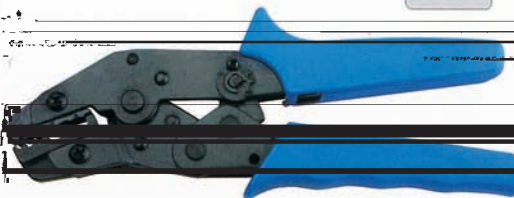

Item No: SN-002

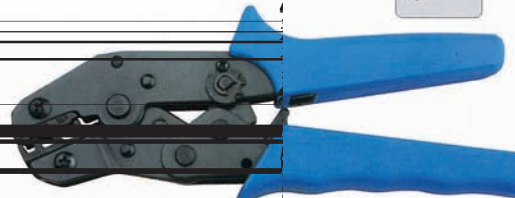

Item No: SN-003



Item No: HD-1101

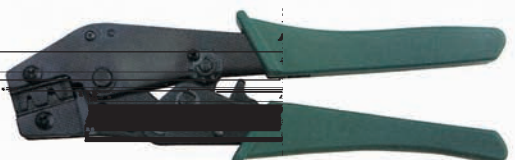

Item No: HD-1102



HAND CRIMPING TOOL



Item No: HD-1103



Item No: HT-106



Item No: HS-0115F



Item No: AP-03B



Item No: AP-03C



Item No: AP-10

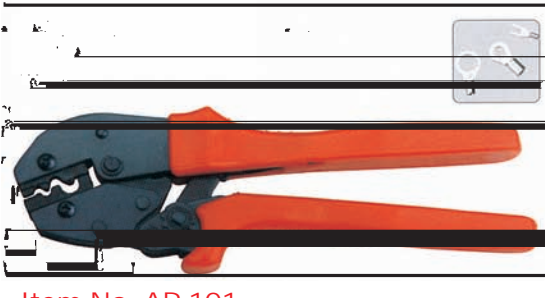

Item No: AP-101



Item No: AP-103



HAND CRIMPING TOOL



Item No: AP-04WF



Item No: AP-04WFL

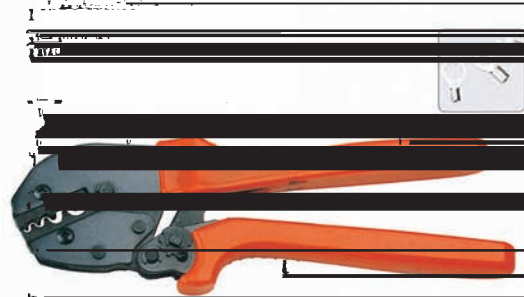

Item No: AP-004



Item No: AP-005

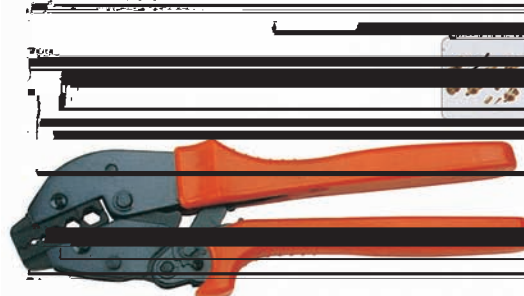

Item No: AP-005H



Item No: AP-006

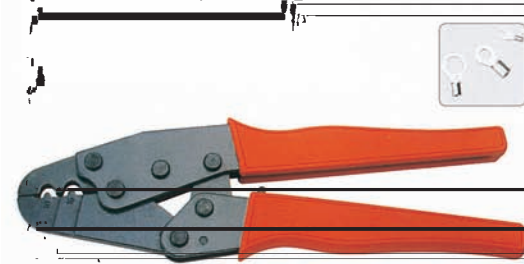

Item No: TP-680

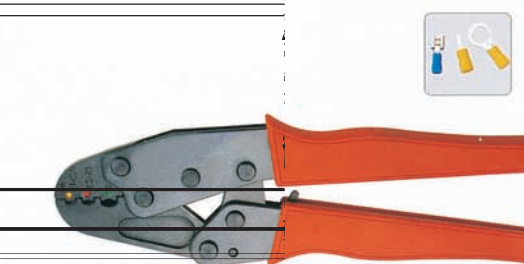

Item No: TP-690



HAND CRIMPING TOOL

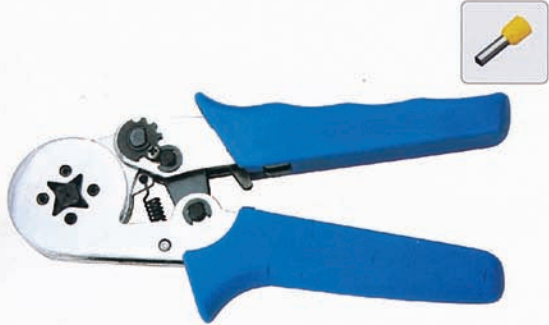

Item No: HSC8 6-4



Item No. Q-175, Q-200



Item No: YG-202A



Item No. Q-175A

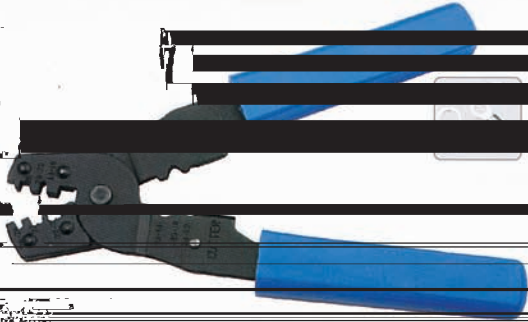

Item No: YG-202B

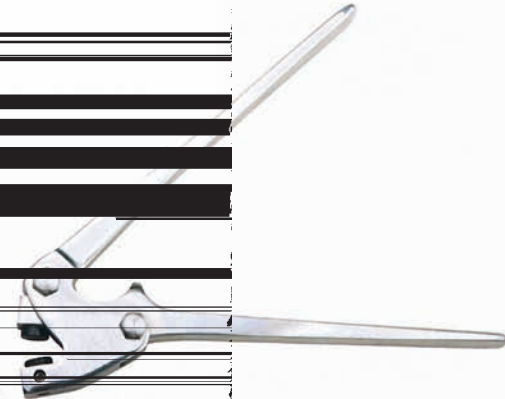

Item No. Q-200A



WIRE STRIPPER

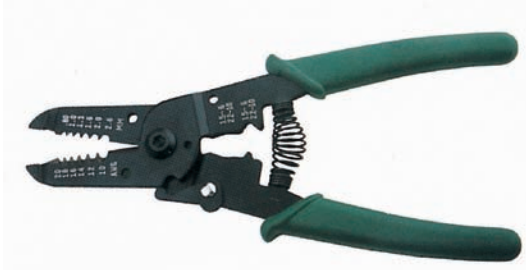

Item No: HS-2403



Item No: HS-2204



Item No: HT-1041

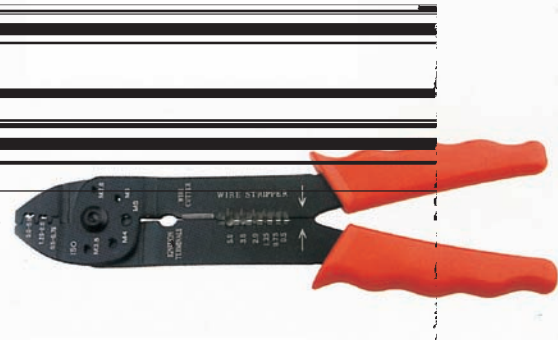

Item No: HS-2003

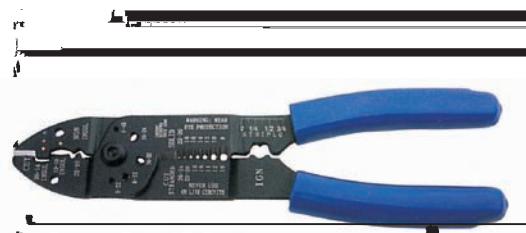

Item No: HS-2103

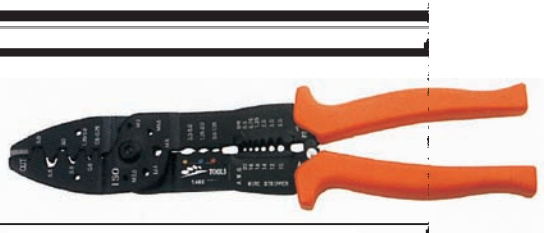

Item No: HS-2004



Item No: HS-2603

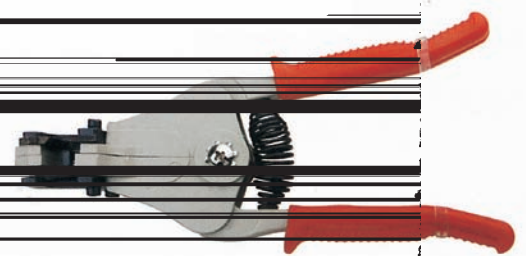

Item No: HY-369A, B, C



NET PLIERS



Item No: G-376E

Item No: HS-2303



Item No: HY-200R

Item No: G-376M

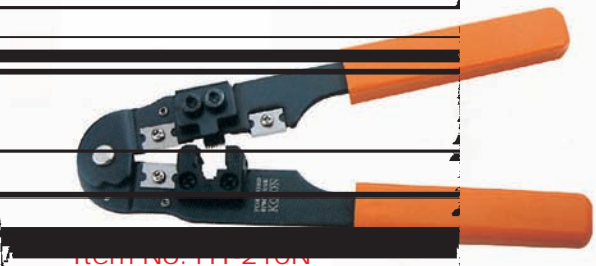

Item No: HY-210R

Item No: G-268

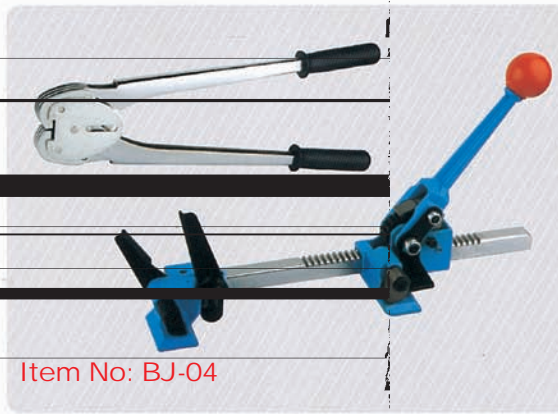
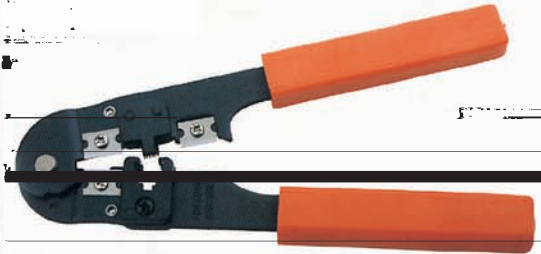

Item No: BJ-04

Item No: HY-2096



CABLE CUTTER



Item No: CPC-40A



Item No: CPC-40BL



Item No: CPC-52A



Item No: CPC-40B

Item No	cutting force	cutting range	Length	Weight	Package	weight of case
---------	---------------	---------------	--------	--------	---------	----------------

--	--	--	--	--	--	--



Item No: CPC-85B



Item No: CC-50B

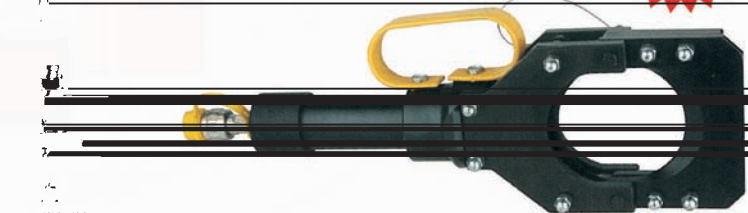

Item No: CPC-100B

Item No	cutting force	cutting range	Length	Weight	Package	weight of case
---------	---------------	---------------	--------	--------	---------	----------------

--	--	--	--	--	--	--



CABLE CUTTER



Item No: HS-125

Item No: HS-250

Item No: HS-300

Item No: CC-325

Item No: CC-500

Item No: CC-100



HYDRAULIC PUNCH DRIVER



Item No: SYK-8

Item No: SYK-8A

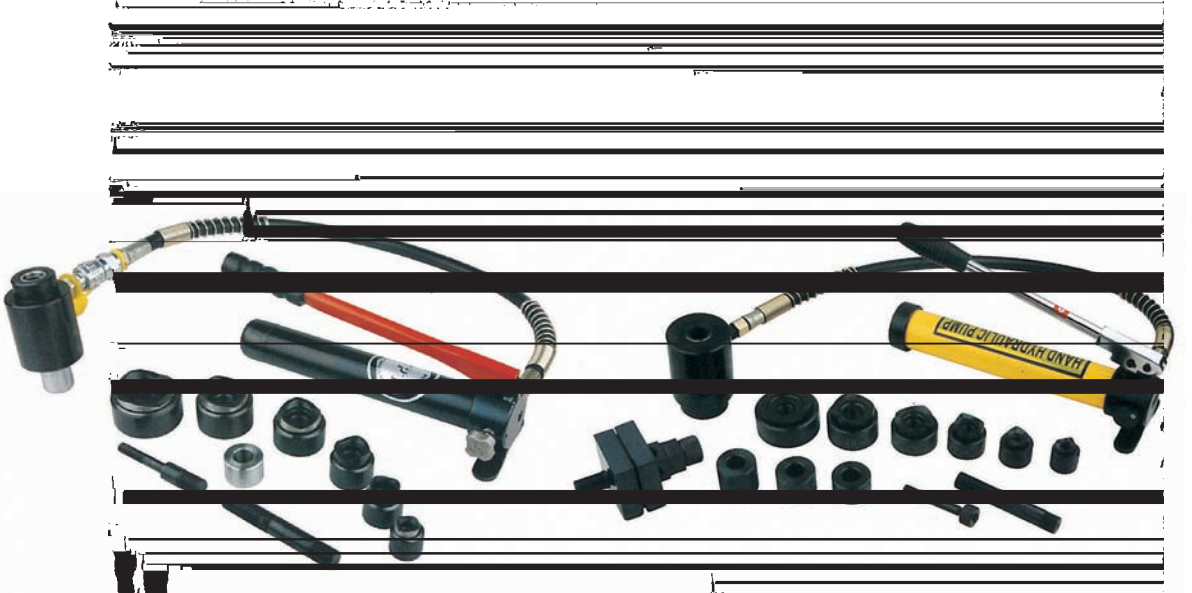

Item No: SYK-8B

SYK-15

FUNCTION



PUNCH DRIVER

PUNCH DRIVER

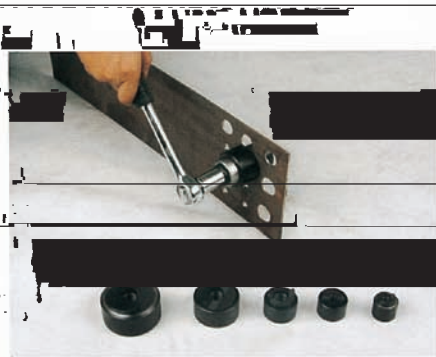
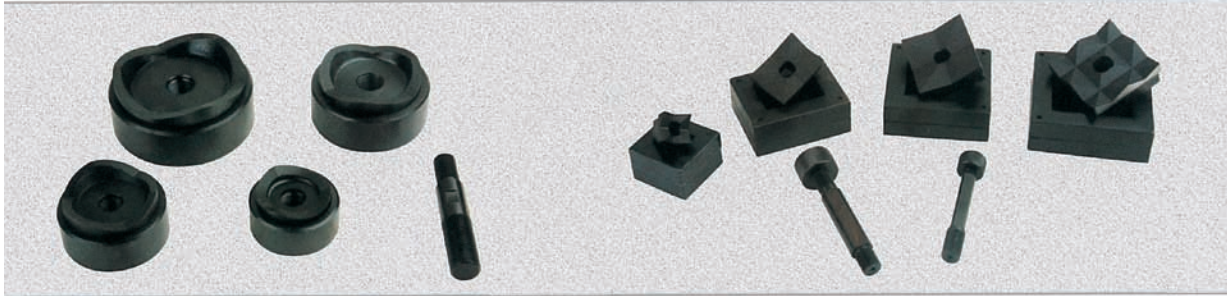

Item No: CC-60

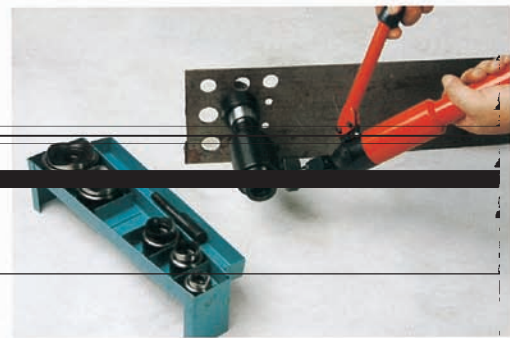



HYDRAULIC PUNCH DRIVER & CUTTING TOOL



Item No: CH-60



Item No: CH-70



Item No: SYD-35

Item No	Max thickness of sheet(mm)	Punching force (T)	depth of throat (mm)	Height approx. (mm)	Weight approx. (Kg)	Accessories (mm ²)	Note
---------	----------------------------	--------------------	----------------------	---------------------	---------------------	--------------------------------	------



CUTTING TOOL

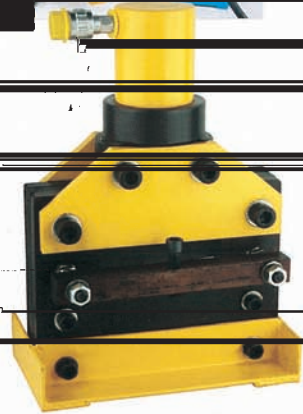

Item No: CWC-150/CWC-200

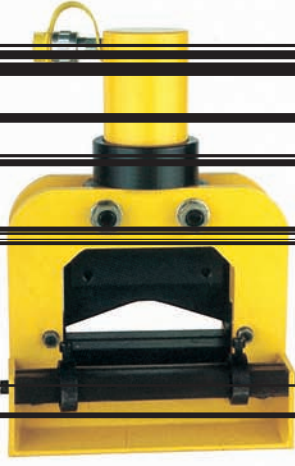

Item No: CWC-150V

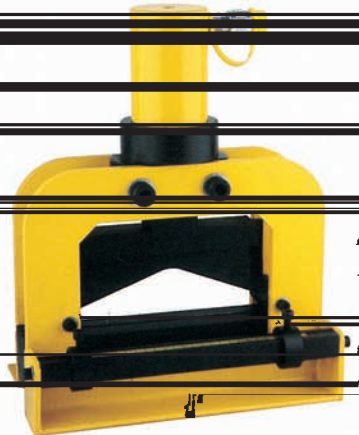

Item No: CWC-200V

Item No	Max thickness of sheet(mm)	Width of sheet (mm)	cutting force (T)	Height (mm)	Weight approx. (Kg)	Note
---------	----------------------------	---------------------	-------------------	-------------	---------------------	------



BRASS BENDER

BRASS BENDER

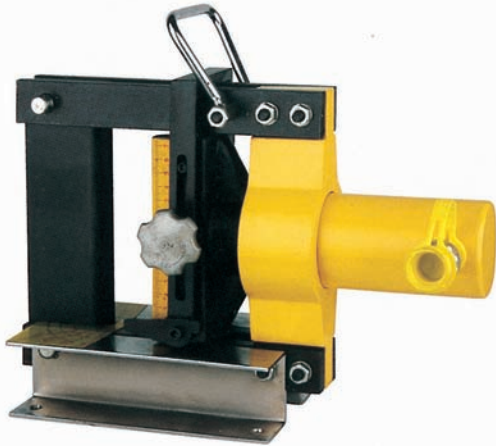

Item No: CB-150D



Item No: CB-200A

FUNCTION

Item No	Bending Force	Max thickness of sheet	Width of sheet	Height	Weight

Item No: VHB-150

VHB-150 Multi-functionalline production machine





CUTTING TOOL

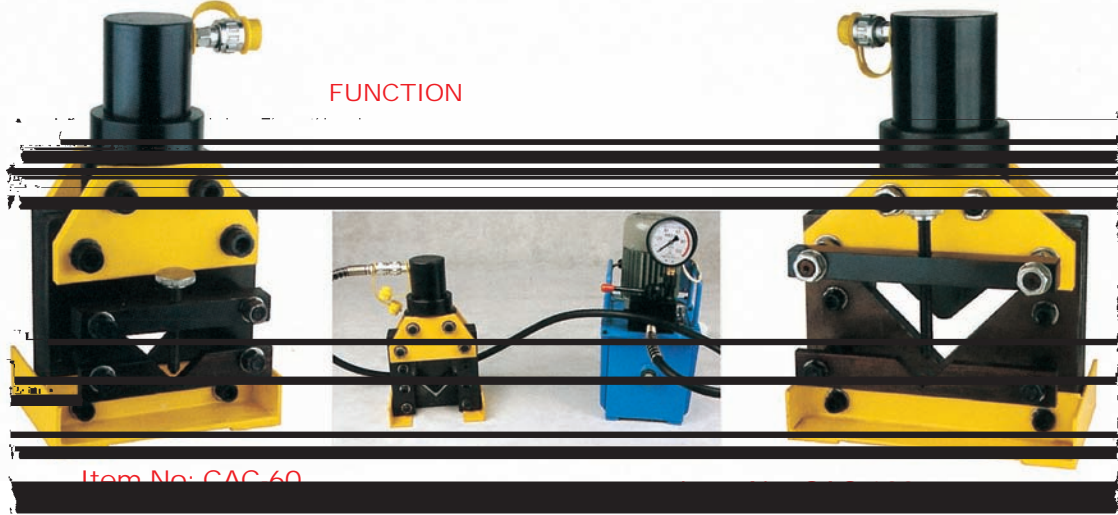

FUNCTION

Item No: CAC-60

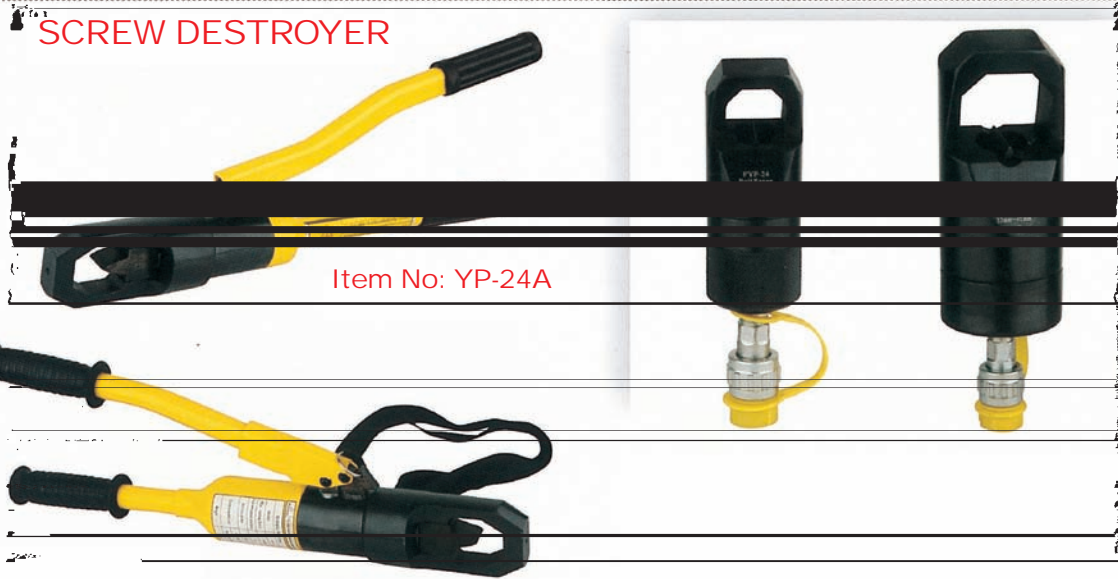

SCREW DESTROYER

Item No: YP-24A

Item No	Max cutting force	Stroke	Length	Weight approx	Package	Weight of Box	Size of nut:



CUTTING TOOL



Item No: RC-16

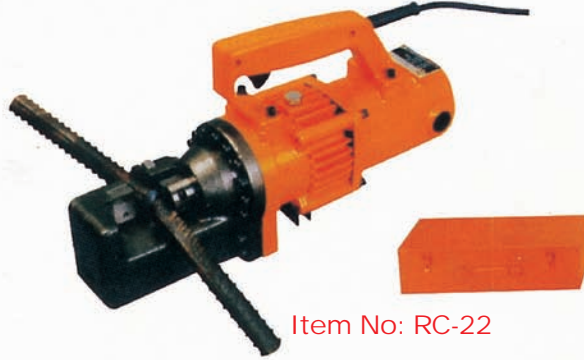

Item No: RC-22

Item No	Cutting range	Length

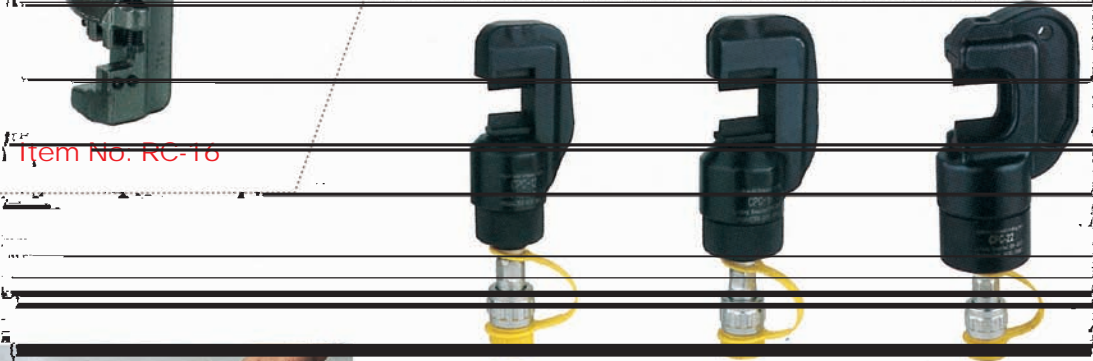

Item No: CPC-12 Item No: CPC-16 Item No: CPC-22

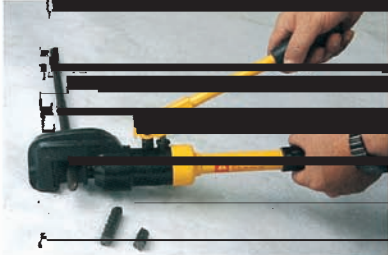

Item No	Cutting range	Length



Item No: CPC-16A

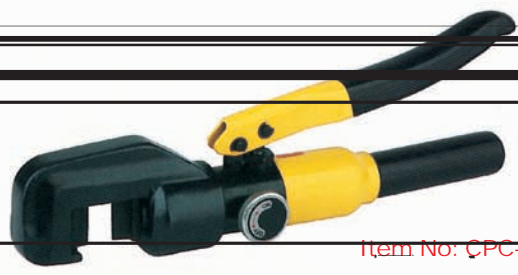

Item No: CPC-12A

Item No	Cutting range	Length	Weight	Package	Weight of case



HYDRAULIC PUMP



Item No: CP-180



Item No: CP-180B

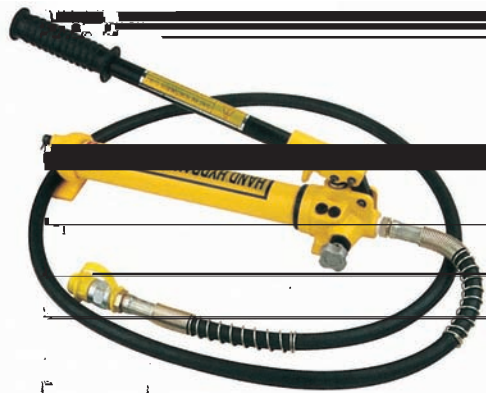

Item No: CP-390



Item No: CP-630



Item No: CP-700

CHARACTERISTIC:





HYDRAULIC PUMP

ELECTRIC PUMP

CHARACTERISTIC:

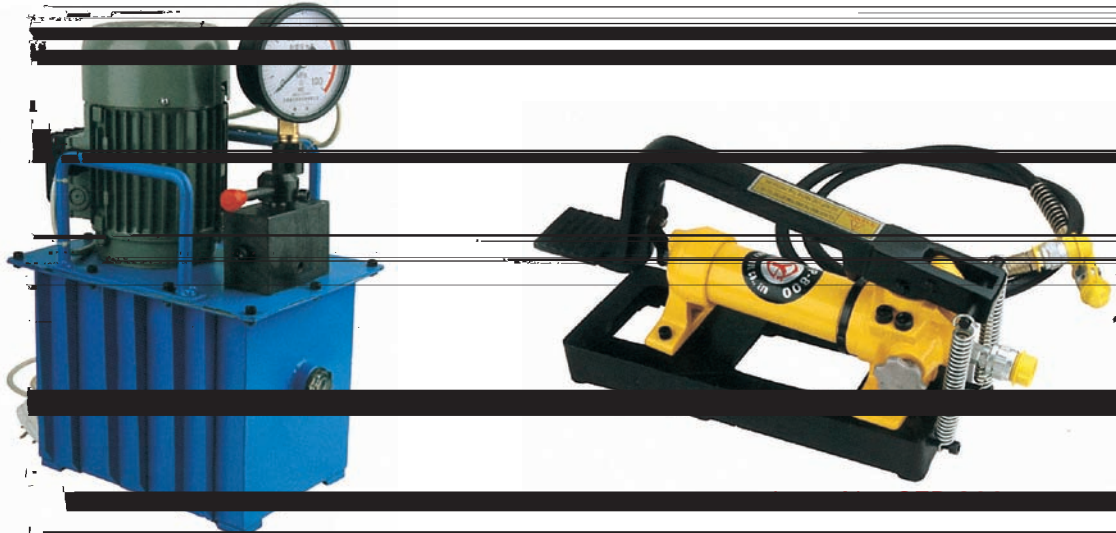

	pressure	pressure	pressure
--	----------	----------	----------

Item.No	Max output pressure	Deposit volume of oil	Weight	Length	Weight of case
---------	---------------------	-----------------------	--------	--------	----------------

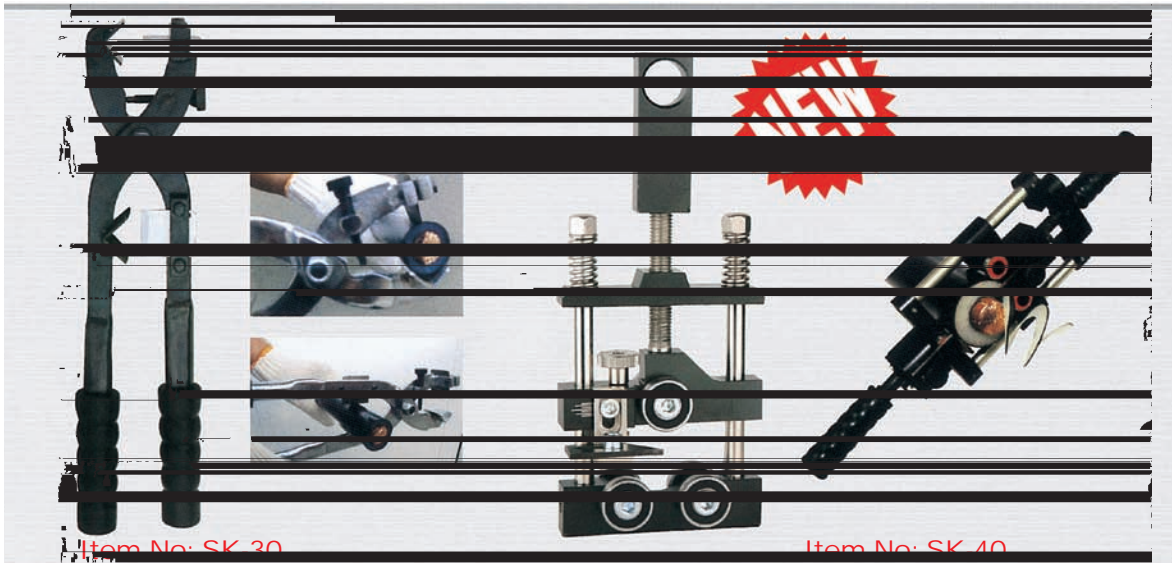

Item No: SK 30

Item No: SK 40

Item.No	Stripping range	Weight	Length	Note
---------	-----------------	--------	--------	------



HYDRAULIC PULLER

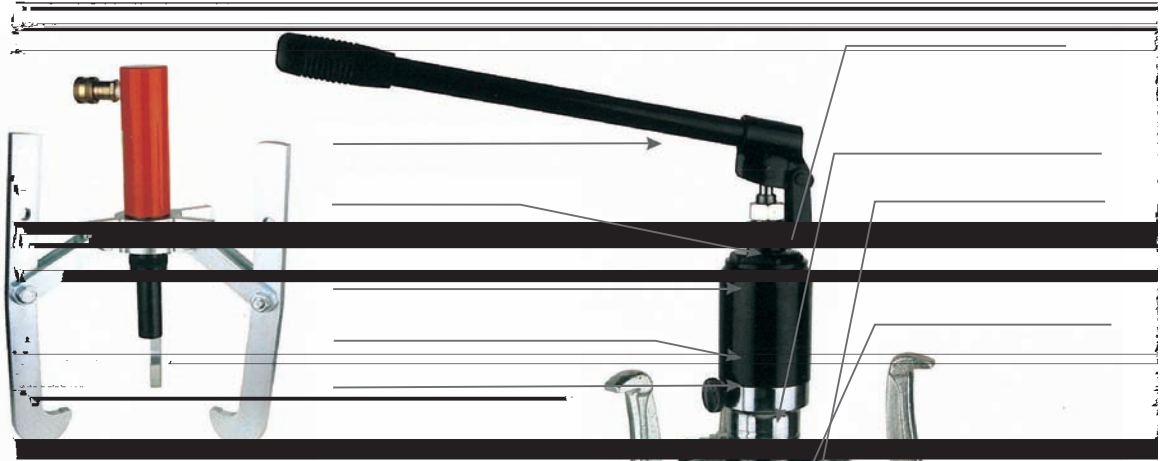

Item No: CPS

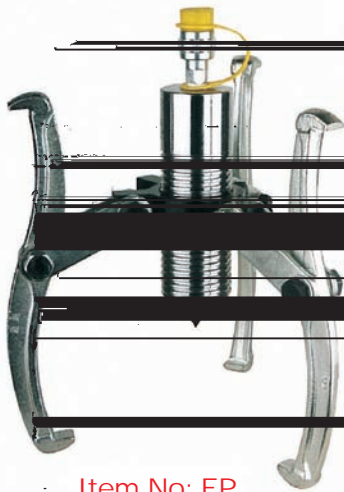

Item No: CK

FUNCTION

Item No: EP

Item No.	Output	Spread	Reach	Ares Travel	Item No.	Output	Spread	Reach	Ares Travel



HYDRAULIC PIPE BENDER



Item No: CPB

Item No: SWG
Integral-unit style

FUNCTION

Item No.	Output (T)	Stroke (mm)	Bending range (mm)	Thickness of pipe (mm)	Weight: approx (kg)	Package	Weight of box	Pipe moulds

Item No.	Output (T)	Bending range (mm)			Stroke (mm)	Oil reseaves (cc)	Weight (kg)
		Thin-wall conduit tube	Thick-wall conduit tube	Carbon steel pipe(Gas pipe)			



TAKE-UP

Item No.	Max Tensile Force (T)	Stroke (mm)	Weight: approx (KG)	Weight (mm)



FITTING TOOLS

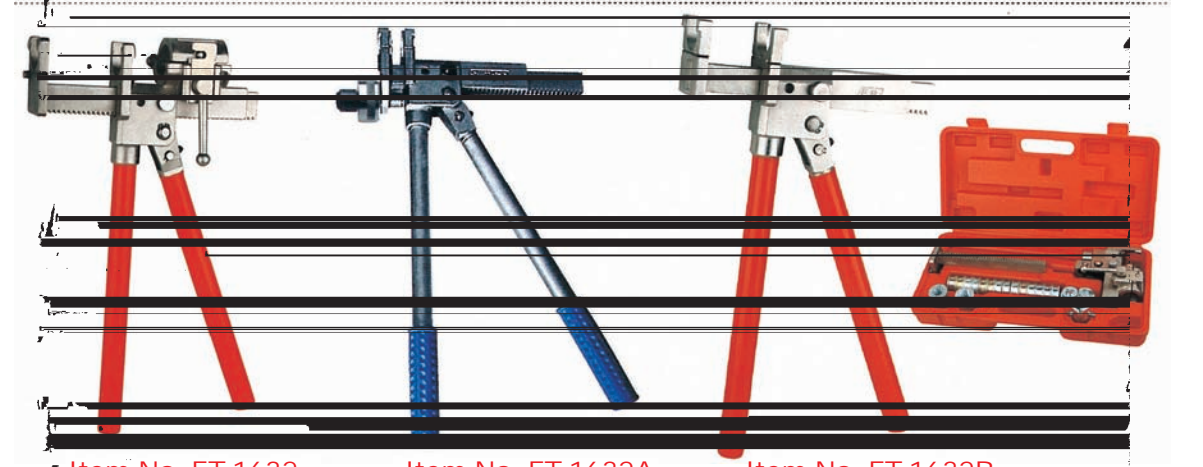
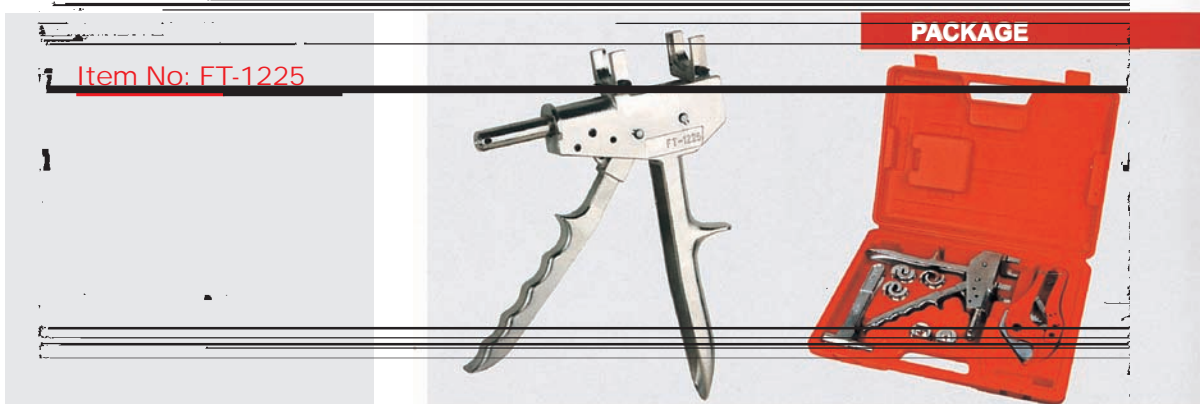
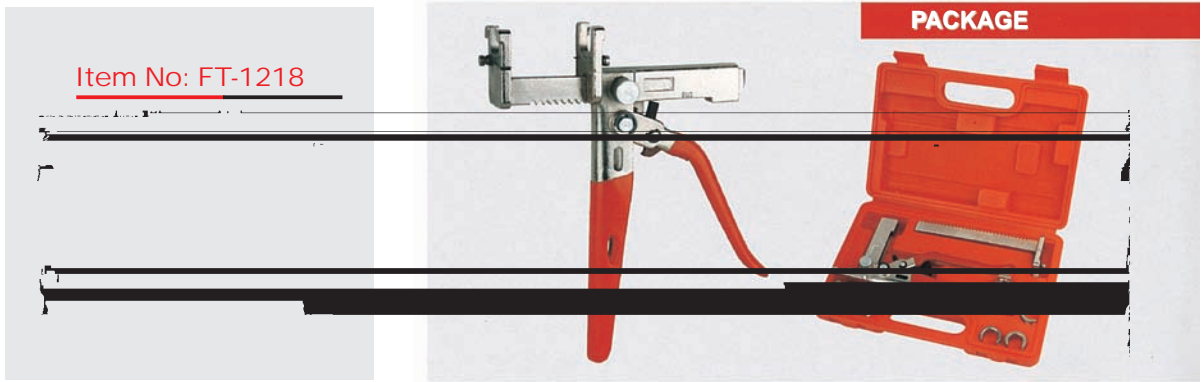

Item No: FT-1632

Item No: FT-1632A

Item No: FT-1632B

Item No	Connecting range	Stroke	Weight	Package	weight of box	Accessories
---------	------------------	--------	--------	---------	---------------	-------------



FITTING TOOLS



Item No: ETM20



Item No: ETM32



Item No: JT-1632



Item No: PE-1632

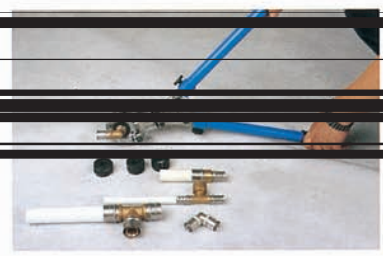



FITTING TOOLS

Item No: FT-18

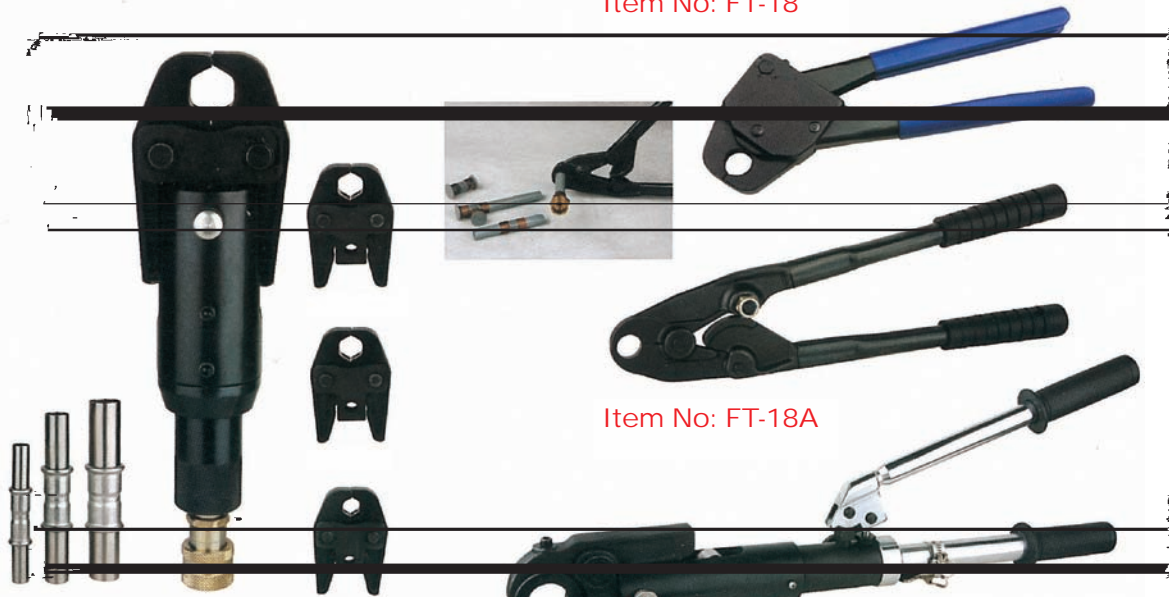

Item No: FT-18A



Item No: FT-1325

Item No: ETV-1632

Model	Material	Color	Stroke	Length	Weight
FT-18	Aluminum	Black	150mm	180mm	0.5kg
FT-18A	Aluminum	Black	150mm	180mm	0.5kg
FT-1325	Aluminum	Silver	150mm	180mm	0.5kg
ETV-1632	Aluminum	Black	150mm	180mm	0.5kg

PVC PIPE CUTTER



Item No: U-25



Item No: U-32

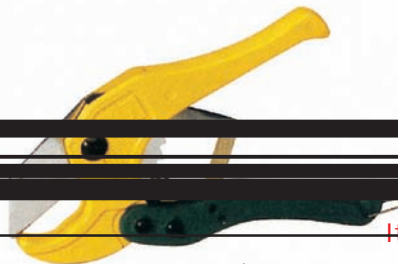
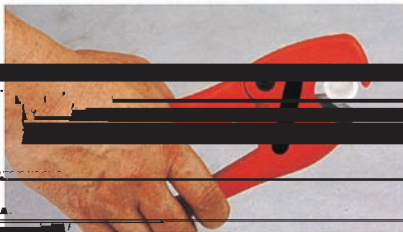

Item No: U-42



RMC SUPER THIN SINGLE HYDRAULIC CYLINDER

RMC SUPER THIN SINGLE HYDRAULIC CYLINDER

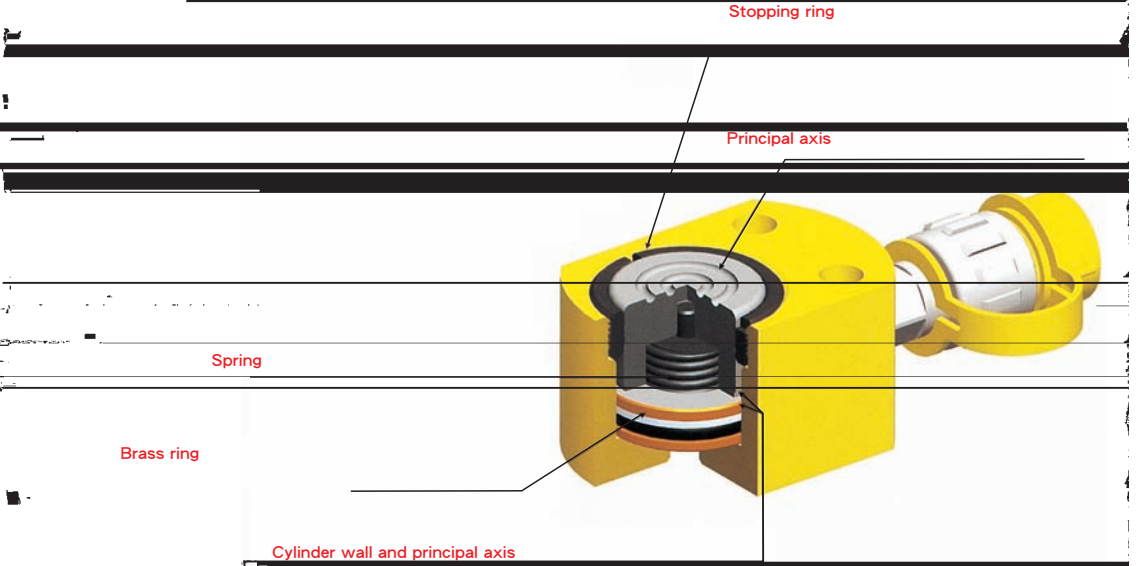

Item.No	Output (T)	Stroke (mm)	effective area (cm ²)	oil capacity (L)	height of product (mm)	extended height (mm)	Outside dia (ø mm)	bore dia (ø mm)	plunger Dia (ø mm)	Thread for input oil-port (ZG)	Saddle protrusion form Plgr (mm)	Weight (Kg)
---------	------------	-------------	-----------------------------------	------------------	------------------------	----------------------	--------------------	-----------------	--------------------	--------------------------------	----------------------------------	-------------



RMC-L MULTISTAGE HYDRAULIC CYLINDER

RMC-L MULTISTAGE
HYDRAULIC CYLINDER

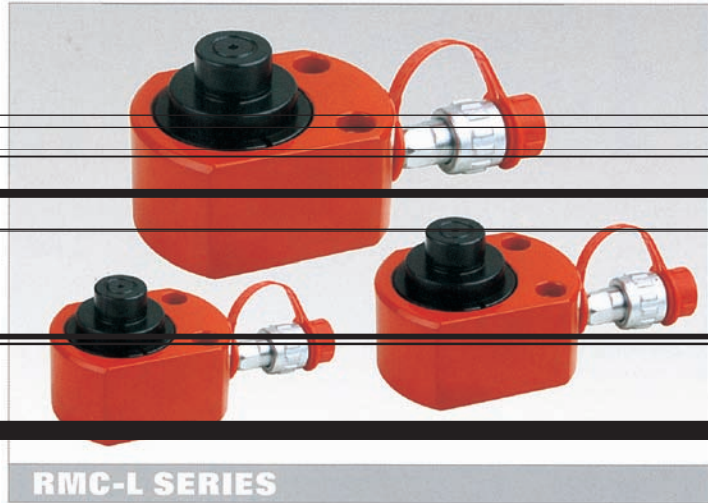

Stopping ring

Principal axis

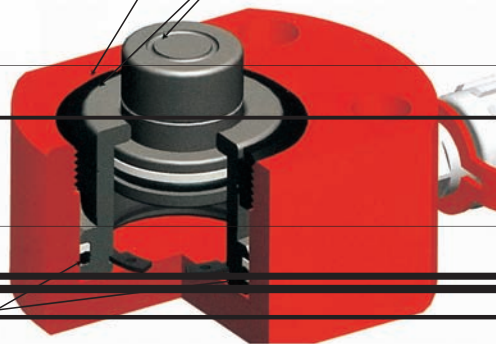

Item.No	Output (T)	Stroke (mm)	effective area (cm ²)	oil capacity (L)	height of product (mm)	extended height (mm)	Outside dia (∅ mm)	bore dia (∅ mm)	plunger Dia (∅ mm)	Weight (Kg)
---------	---------------	----------------	--------------------------------------	---------------------	------------------------------	----------------------------	-----------------------	--------------------	-----------------------	----------------



RC SINGLE HYDRAULIC CYLINDER

RC SINGLE HYDRAULIC CYLINDER

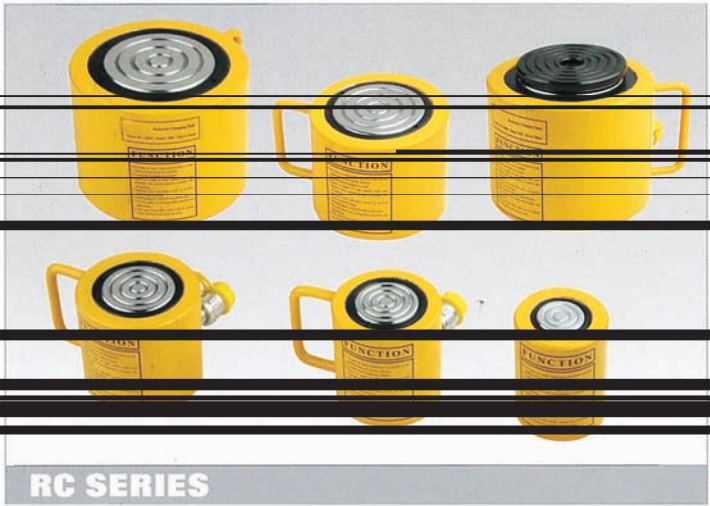

Stopping ring

Spring

Cylinder wall and plunger

Brass ring

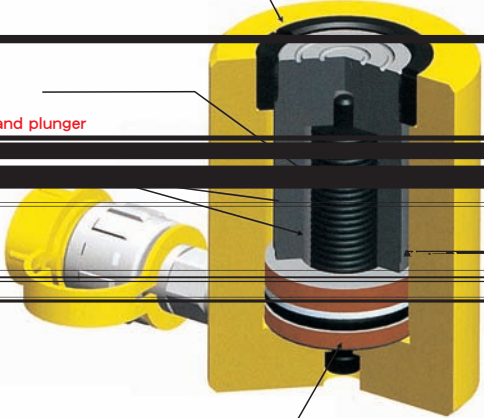

Item No	Output	Stroke	effective area	oil capacity	height of	extended	Outside dia	bore dia	plunger Dia	Thread for	Saddle	Weight
	(L)	(mm)	(cm ²)	(L)	retracted position (mm)	height (mm)	(\varnothing mm)	(\varnothing mm)	(\varnothing mm)	input oil port (mm)	protection form DIN 15300-1 (mm)	(Kg)



RSC SINGLE HYDRAULIC CYLINDER

RSC SINGLE HYDRAULIC CYLINDER



Hardy underlay

Stopping ring

Cylinder wall and principal axis

O-ring

Brass ring

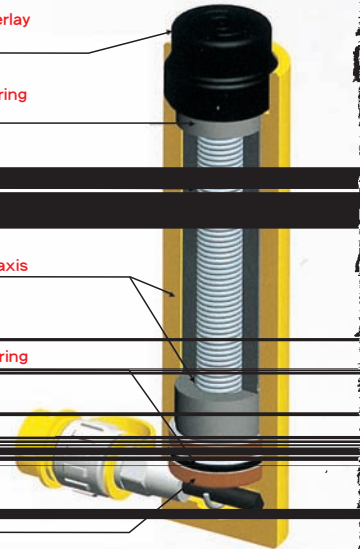

Item No	Output (T)	Stroke (mm)	effective area (cm ²)	oil capacity (L)	height of product (mm)	extended height (mm)	Outside dia (φ mm)	bore dia (φ mm)	plunger Dia (φ mm)	Thread for input oil-port (ZG)	Saddle protrusion form Plgr (mm)	Weight (Kg)
---------	------------	-------------	-----------------------------------	------------------	------------------------	----------------------	--------------------	-----------------	--------------------	--------------------------------	----------------------------------	-------------



RCH SINGLE HYDRAULIC CYLINDER

RSC SINGLE HYDRAULIC CYLINDER

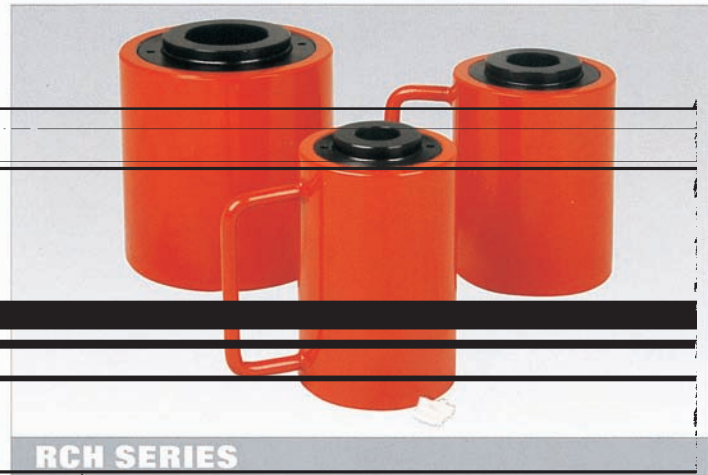

Hardy underlay

Stopping ring

Spring

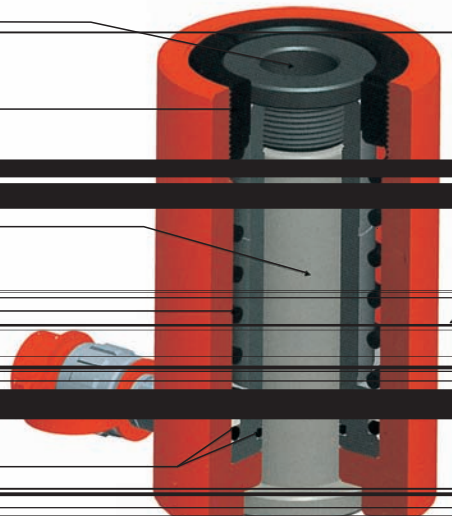

Item No	Output (T)	Stroke (mm)	Effective area (cm ²)	Oil capacity (L)	height of product (mm)	extended height (mm)	Outside dia (ø mm)	bore dia (ø mm)	plunger Dia (ø mm)	Weight (Kg)
---------	------------	-------------	-----------------------------------	------------------	------------------------	----------------------	--------------------	-----------------	--------------------	-------------